

 **CONVEX**[®]
HANDLES KNOBS DESIGN & PRODUCTION



MADE IN GREECE

KLAMKI I AKCESORIA 2023 / 2024



HISTORIA

CONVEX powstał w 1991 roku. Jego założycielem jest Panagiotis PANTAZELOS, który działa w branży okuć od 1973 roku. Firma mieści się we własnych obiektach przy 93 G. Gennimata Avenue, Magoula, Attiki. Są to starannie zaprojektowane budynki spełniające najwyższe standardy. Convex jest jednostką zintegrowaną pionowo, a wszystkie etapy produkcji prowadzone są w zakładach własnych.

Produkty firmy to:

- klamki i gałki do drzwi,
- uchwyty i gałki meblowe,
- produkty wykonane na zamówienie.

Convex posiada rozległą sieć dealerów w całej Grecji, starannie wspierając i dostarczając im wiedzę techniczną zbudowaną dzięki wieloletniemu zaufaniu i doświadczeniu. Działalność eksportowa CONVEX obejmuje ponad 24 kraje na całym świecie dzięki inwestycjom w dziedzinie projektowania, a także dbałości o wszystkie szczegóły otaczające liczne aspekty wszystkich faz produkcji.

Convex, po analizie funkcji społecznych i ciągłym poszukiwaniu nowych, korzystniejszych materiałów poprawiających jakość życia, chroniących ludzi i środowisko, jako pierwsza firma w Grecji i jedna z pierwszych na świecie uzyskała certyfikat Copper Development Institute na produkcję produktów przeciwdrobnoustrojowych na bazie miedzi.

Od początku swojego funkcjonowania CONVEX jest firmą rodzinną. Aktualnie w jej prowadzenie włączone zostało drugie pokolenie, które ma ten sam zapał do kreowania innowacyjnego, stylowego, funkcjonalnego i wysokiej jakości produktu.

KIM JESTEŚMY

Convex to grecki producent designerskich klamek wykonanych z najwyższej jakości materiałów. Łączy w sobie długie doświadczenie w produkcji wyrobów metalowych oraz dużą wiedzę techniczną projektantów.

Dzięki wysiłkowi znanych architektów i projektantów, kolekcja Convex odznacza się wyraźną elegancją, wyrafinowaniem, perfekcją wykończenia i unikalnością. Filozofię Convex najlepiej można opisać jako model czterofilarowy. Kreatywność, Innowacja, Technologia i Pasja.

PROCES PRODUKCYJNY

CONVEX to pionowo zintegrowana firma produkcyjna, wykorzystująca w procesie produkcji różne metale i stopy, takie jak mosiądz, aluminium, odlewy ciśnieniowe na bazie cynku, stal nierdzewna, miedź itp. Całość sekwencji produkcyjnej odbywa się w naszych zakładach. W ten sposób cały proces jest w pełni kontrolowany. Pozwala to na dużą elastyczność we współpracy z klientami i kontrahentami na rynku greckim i międzynarodowym.

Działy produkcyjne CONVEX obejmują:



PROJEKT PRODUKTU

W pełni wyposażona hala maszynowa, w której po projekcie produktu powstaje forma jako narzędzie produkcyjne wykorzystywane w procesie odlewania.



ODLEWANIE CIŚNIENIOWE

złota i brązu w trzech prasach odlewniczych.



AUTOMATYCZNE TOKARKI

do produkcji elementów obrabianych z mosiądzu i aluminium. Maksymalna średnica, która może zostać wyprodukowana to Ø 60 mm.



DZIAŁ OBRÓBK

przy użyciu maszyn transferowych specjalnie zbudowanych na potrzeby produkcyjne. Prasy do cięcia, wiertarki i piły służą również do wykańczania części wymiarowej i funkcjonalnej naszych produktów.



WYKOŃCZENIE WIBRACYJNE

wykonywane jest jako wstępny etap obróbki metalu. Posiadamy również wiele ręcznych lub automatycznych maszyn do obróbki ściernej.



DZIAŁ WYKOŃCZEŃ

gdzie końcowe polerowanie jest wykonywane w satynowym lub błyszczącym wykończeniu. W zależności od rozmiaru i geometrii części, stosowane są maszyny transferowe i zrobotyzowane.



DZIAŁ GALWANIZACJI

gdzie w pełni automatyczna instalacja sterowana 7 nośnikami i posiadająca 70 zbiorników przetwarza całość produkowanych przez nas półfabrykatów. Metale do obróbki to mosiądz, złota, miedź, aluminium i stal nierdzewna. Procesy obejmują miedziowanie, niklowanie, mosiądzowanie i chromowanie, a także lakierowanie. Możliwa jest obróbka detali do 2,8 m długości i 1,3 m wysokości.



PROSZKOWE LAKIEROWANIE ELEKTROSTATYCZNE I OKSYDOWANIE METALU

odbywa się na wydzielonym dziale dla części produktów, kończąc tym samym całość procesów obróbki niektórych produktów.



KONTROLA JAKOŚCI

to osobny i najważniejszy dział, w którym przeprowadzane są kontrole w celu sprawdzenia, czy produkty spełniają określone normy w Systemie Kontroli Jakości CONVEX.



MOCOWANIE, MONTAŻ I PAKOWANIE

gotowych produktów do przechowywania przed sprzedażą za pośrednictwem sieci dystrybucji.

KONTROLA JAKOŚCI – GWARANCJE

CONVEX wdrożył zintegrowaną politykę jakości. Poprzez ustanowienie zasad kontroli dla wszystkich etapów – od surowca poprzez proces produkcji do produktu końcowego – CONVEX gwarantuje najwyższą jakość i satysfakcję klienta.



W listopadzie 2010 firma Convex uzyskała certyfikat do stosowania jej własnego systemu kontroli jakości według normy ISO 9001: 2008 a w marcu 2019 roku Convex uzyskał certyfikat zgodnie z normą dotyczącą zarządzania ochroną środowiska ISO 14001: 2015.



Starając się zapewnić najwyższą jakość swoich produktów, firma Convex współpracuje z akredytowanymi laboratoriami, w których przeprowadzane są testy wytrzymałościowe przeprowadzane podczas utleniania w kabinie solnej zgodnie z EN 1670: 2007 „Okucia budowlane – Odporność na korozję – Wymagania i metody badań.”



Convex oferuje gwarancję użytkowania na wszystkie klamki dla 500 000 cykli.



Convex oferuje 10 lat dodatkowych gwarancji odporności powierzchni na korozję dla wszystkich chromowanych klamek.



Convex współpracuje z uznanym włoskim laboratorium LAPI, gdzie bada odporność ogniową na klamki w kontrolowanym środowisku zgodnie z normą EN 1634-2:2008 („Badania kontrolne odporności na ogień i dym zamknięć do drzwi i otwieralnych okien oraz elementów okuć budowlanych”).



Convex przestrzega normy EN 1906:2012 „Okucia budowlane. Klamki i gałki drzwiowe z tarczami. Wymagania i metody badań” w celu oceny jakości swoich produktów. Wyniki, testy i ocena odpowiadają 8-cyfrowemu sortowaniu kodów wymagane przez tą normę.



S02 - Mosiądz Satyna



S04 - Chrom



S05 - Nikiel Satyna



S06 - Biały Matowy



S19 - Czarny Matowy



S20 - Złoty



S23 - Bordowy



S24 - Chrom Satyna



S26 - Mosiądz Matowy



S73 - Mosiądz Antyczny









































S75 - Tytan



S77 - Brąz Matowy



S96 - Biały

Klamki na rozetach SLIM			Klamki na rozetach kwadratowych			Klamki na rozetach okrągłych			designers & premium						
		model	strona					model	strona			model	strona		
		1605 SLIM	6		New	2425	16		New	2095	28		2405	38	
		1515 SLIM	7			1605	17			1755	29		2415	39	
		1505 SLIM	8			1555	18			425	29		2195	39	
		1495 SLIM	9			1535	18			1515	30-31		2165	40	
		1485 SLIM	10			1495	19			1505	32-33		New	1935	41
		1145 SLIM	11			1145	20			1485	34-35		New	1925	42
		865 SLIM	11			1125	21							1775	43
	New	2295 SLIM	13			1115	22							1745	44
	New	2285 SLIM	13			1085	23							1625	45
	New	2275 SLIM	14			865	24								
	New	2265 SLIM	14			925	25								
						785	26								
						697	26								



— SLIM —

NOWA
ODSŁONA

KLAMKI NA ROZETACH SLIM

MODEL
1605 SLIM

— SLIM —

NOWA
ODSŁONA



Chrom Satyna - S24
25-398



BDR 185,00 227,55



25-438 **WK 68,00** 83,64



25-432 **WB 68,00** 83,64



25-426 **WC 109,00** 134,07

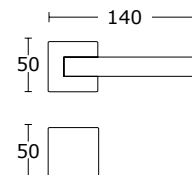

Czarny Matowy - S19
25-397



BDR 185,00 227,55



25-436 **WK 68,00** 83,64



25-430 **WB 68,00** 83,64



25-424 **WC 109,00** 134,07

— SLIM —

NOWA
ODSŁONA

MODEL
1515 SLIM



Czarny Matowy - S19
25-399



BDR 185,00 227,55



25-436 **WK 68,00** 83,64



25-430 **WB 68,00** 83,64



25-424 **WC 109,00** 134,07

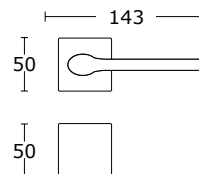

Nikiel Satyna - S05
25-402



BDR 185,00 227,55



25-439 **WK 68,00** 83,64



25-433 **WB 68,00** 83,64



25-427 **WC 109,00** 134,07



Chrom Satyna - S24
25-400



BDR 185,00 227,55



25-438 **WK 68,00** 83,64



25-432 **WB 68,00** 83,64



25-426 **WC 109,00** 134,07

MODEL
1505 SLIM

— SLIM —

NOWA
ODSŁONA



Chrom Satyna - S24
25-406



BDR 178,00 218,94



25-438 **WK 68,00** 83,64



25-432 **WB 68,00** 83,64



25-426 **WC 109,00** 134,07

Mosiądz Satyna - S02
25-405



BDR 194,00 238,62



25-437 **WK 74,00** 91,02



25-431 **WB 74,00** 91,02



25-425 **WC 119,00** 146,37

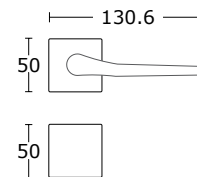

Czarny Matowy - S19
25-404



BDR 178,00 218,94



25-436 **WK 68,00** 83,64



25-430 **WB 68,00** 83,64



25-424 **WC 109,00** 134,07



Nikiel Satyna - S05
25-408



BDR 178,00 218,94



25-439 **WK 68,00** 83,64



25-433 **WB 68,00** 83,64



25-427 **WC 109,00** 134,07

— SLIM —

NOWA
ODSŁONA

MODEL
1495 SLIM



Czarny Matowy - S19
25-410



BDR 185,00 227,55



25-436 **WK 68,00** 83,64



25-430 **WB 68,00** 83,64



25-424 **WC 109,00** 134,07



Chrom - S04
25-413



Nikiel Satyna - S05
25-414



BDR 185,00 227,55



25-439 **WK 68,00** 83,64



25-433 **WB 68,00** 83,64



25-427 **WC 109,00** 134,07



BDR 203,00 249,69



25-435 **WK 74,00** 91,02



25-429 **WB 74,00** 91,02



25-383 **WC 119,00** 146,37

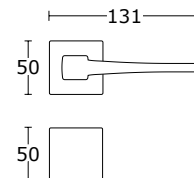

MADE
IN
GREECE



Mosiądz Satyna - S02
25-411



Złoty - S20
25-415



Chrom Satyna - S24
25-412



BDR 203,00 249,69



25-437 **WK 74,00** 91,02



25-431 **WB 74,00** 91,02



25-425 **WC 119,00** 146,37



BDR 203,00 249,69



25-440 **WK 74,00** 91,02



25-434 **WB 74,00** 91,02



25-428 **WC 119,00** 146,37



BDR 185,00 227,55



25-438 **WK 68,00** 83,64



25-432 **WB 68,00** 83,64



25-426 **WC 109,00** 134,07

MODEL
1485 SLIM

— SLIM —

NOWA
ODSŁONA



Mosiądz Satyna - S02
25-419



BDR 203,00 249,69



25-437 **WK 74,00** 91,02



25-431 **WB 74,00** 91,02



25-425 **WC 119,00** 146,37



Czarny Matowy - S19
25-564



BDR 185,00 227,55



25-436 **WK 68,00** 83,64



25-430 **WB 68,00** 83,64



25-424 **WC 109,00** 134,07



Chrom Satyna - S24
25-416



BDR 185,00 227,55



25-438 **WK 68,00** 83,64



25-432 **WB 68,00** 83,64



25-426 **WC 109,00** 134,07

— SLIM —

NOWA
ODSŁONA

MODEL
1145 SLIM



Czarny Matowy - S19
25-421



BDR 226,00 277,98



25-436 **WK 68,00** 83,64



25-430 **WB 68,00** 83,64



25-424 **WC 109,00** 134,07

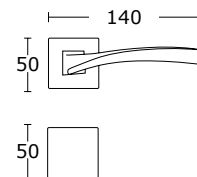

— SLIM —

NOWA
ODSŁONA

MODEL
865 SLIM



Chrom Satyna - S24
25-423



BDR 199,00 244,77



25-438 **WK 68,00** 83,64



25-432 **WB 68,00** 83,64



25-426 **WC 109,00** 134,07



Czarny Matowy - S19
25-362



BDR 199,00 244,77



25-436 **WK 68,00** 83,64



25-430 **WB 68,00** 83,64



25-424 **WC 109,00** 134,07

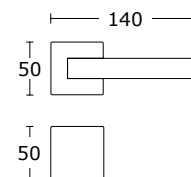

— SLIM —
NOWA
LINIA



MODEL
2295 SLIM

NOWA LINIA



Czarny Matowy - S19
25-566



BDR 125,00 153,75



25-436 **WK 68,00** 83,64



25-430 **WB 68,00** 83,64



25-424 **WC 109,00** 134,07

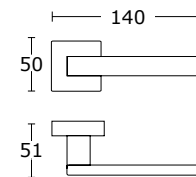

MODEL
2285 SLIM

NOWA LINIA



Czarny Matowy - S19
25-567



BDR 125,00 153,75



25-436 **WK 68,00** 83,64



25-430 **WB 68,00** 83,64



25-424 **WC 109,00** 134,07

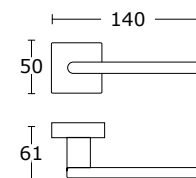

MODEL
2275 SLIM

NOWA LINIA



Czarny Matowy - S19
25-568



BDR 125,00 153,75



25-436 **WK 68,00** 83,64



25-430 **WB 68,00** 83,64



25-424 **WC 109,00** 134,07

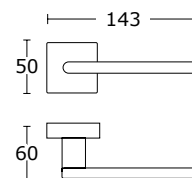

MODEL
2265 SLIM

NOWA LINIA



Czarny Matowy - S19
25-569



BDR 125,00 153,75



25-436 **WK 68,00** 83,64



25-430 **WB 68,00** 83,64



25-424 **WC 109,00** 134,07

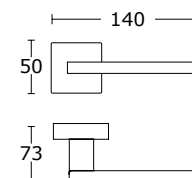



KLAMKI NA ROZETACH KWADRATOWYCH

MODEL
2425

Nowości



Czarny Matowy - S19
25-533



BDR 188,00 231,24



15-162 **WK 59,00** 72,57



15-163 **WB 59,00** 72,57



15-038 **WC 102,00** 125,46

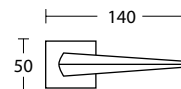

MADE
IN
GREECE



Chrom Satyna - S24
25-532



BDR 188,00 231,24



15-160 **WK 59,00** 72,57



15-161 **WB 59,00** 72,57



15-029 **WC 102,00** 125,46



Chrom - S04
25-534



BDR 206,00 253,38



15-180 **WK 64,90** 79,83



15-182 **WB 64,90** 79,83



15-032 **WC 112,00** 137,76

MODEL
1605



Chrom Satyna - S24
15-397



BDR 178,00 218,94



15-160 **WK 59,00** 72,57



15-161 **WB 59,00** 72,57



15-029 **WC 102,00** 125,46

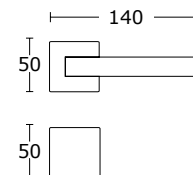

MADE
IN
GREECE



Nikiel Satyna - S05
15-396



BDR 178,00 218,94



15-164 **WK 59,00** 72,57



15-165 **WB 59,00** 72,57



15-026 **WC 102,00** 125,46



Czarny Matowy - S19
25-125



BDR 178,00 218,94



15-162 **WK 59,00** 72,57



15-163 **WB 59,00** 72,57



15-038 **WC 102,00** 125,46

MODEL
1555



Czarny Matowy - S19
15-400



BDR 340,00 418,20



15-162 **WK 59,00** 72,57



15-163 **WB 59,00** 72,57



15-038 **WC 102,00** 125,46

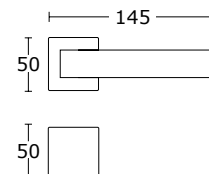

MODEL
1535



Czarny Matowy - S19
15-374



BDR 201,00 247,23



15-162 **WK 59,00** 72,57



15-163 **WB 59,00** 72,57



15-038 **WC 102,00** 125,46

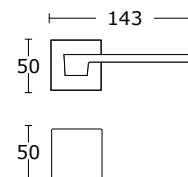



Chrom Satyna - S24
15-340



BDR 178,00 218,94



15-160 **WK 59,00** 72,57



15-161 **WB 59,00** 72,57



15-029 **WC 102,00** 125,46



Chrom - S04
15-341



BDR 195,00 239,85



15-180 **WK 64,90** 79,83



15-182 **WB 64,90** 79,83



15-032 **WC 112,00** 137,76



Mosiądz Satyna - S02
25-366



BDR 195,00 239,85



25-370 **WK 64,90** 79,83



25-372 **WB 64,90** 79,83



25-371 **WC 112,00** 137,76

131

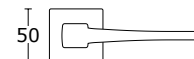

Nikiel Satyna - S05
15-342



BDR 178,00 218,94



15-164 **WK 59,00** 72,57



15-165 **WB 59,00** 72,57



15-026 **WC 102,00** 125,46



Czarny Matowy - S19
25-189



BDR 178,00 218,94



15-162 **WK 59,00** 72,57



15-163 **WB 59,00** 72,57



15-038 **WC 102,00** 125,46



Biały Matowy - S06
25-505



BDR 195,00 239,85



25-517 **WK 64,90** 79,83



25-518 **WB 64,90** 79,83



25-519 **WC 112,00** 137,76

MODEL
1145



Nikiel Satyna - S05
15-016



BDR 219,00 269,37



15-164 **WK 59,00** 72,57



15-165 **WB 59,00** 72,57



15-026 **WC 102,00** 125,46



Czarny Matowy - S19
25-190



BDR 219,00 269,37



15-162 **WK 59,00** 72,57



15-163 **WB 59,00** 72,57



15-038 **WC 102,00** 125,46

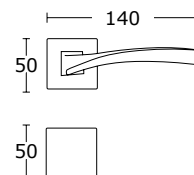

Tytan - S75
15-017



BDR 241,00 296,43



15-187 **WK 64,90** 79,83



15-189 **WB 64,90** 79,83



15-035 **WC 112,00** 137,76



Chrom Satyna - S24
15-015



BDR 219,00 269,37



15-160 **WK 59,00** 72,57



15-161 **WB 59,00** 72,57



15-029 **WC 102,00** 125,46



Mosiądz Antyczny - S73
15-150



BDR 241,00 296,43



15-183 **WK 64,90** 79,83



15-185 **WB 64,90** 79,83



15-041 **WC 112,00** 137,76

MODEL
1125



MADE
IN
GREECE

Chrom - S04
15-067



BDR 310,00 381,30



15-180 **WK 64,90** 79,83



15-182 **WB 64,90** 79,83



15-032 **WC 112,00** 137,76

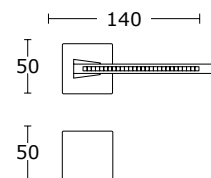

MODEL
1115



Tytan - S75
15-004



BDR 269,00 330,87



15-187 **WK 64,90** 79,83



15-189 **WB 64,90** 79,83



15-035 **WC 112,00** 137,76

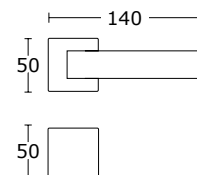

Mosiądz Antyczny - S73
15-203



BDR 269,00 330,87



15-183 **WK 64,90** 79,83



15-185 **WB 64,90** 79,83



15-041 **WC 112,00** 137,76

MODEL
1085



Mosiądz Antyczny - S73
15-011



BDR 264,00 324,72



15-183 **WK 64,90** 79,83



15-185 **WB 64,90** 79,83



15-041 **WC 112,00** 137,76



Czarny Matowy - S19
25-489



BDR 239,00 293,97



15-162 **WK 59,00** 72,57



15-163 **WB 59,00** 72,57



15-038 **WC 102,00** 125,46

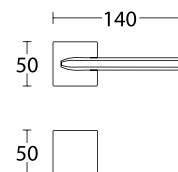

Nikiel Satyna - S05
15-010



BDR 239,00 293,97



15-164 **WK 59,00** 72,57



15-165 **WB 59,00** 72,57



15-026 **WC 102,00** 125,46



Chrom Satyna - S24
15-009



BDR 239,00 293,97



15-160 **WK 59,00** 72,57



15-161 **WB 59,00** 72,57



15-029 **WC 102,00** 125,46

MODEL
865



Mosiądz Matowy - S26
25-511



Czarny Matowy - S19
15-008



BDR 213,00 261,99



15-412 **WK 64,90** 79,83



15-413 **WB 64,90** 79,83



15-414 **WC 112,00** 137,76



BDR 195,00 239,85



15-162 **WK 59,00** 72,57



15-163 **WB 59,00** 72,57



15-038 **WC 102,00** 125,46

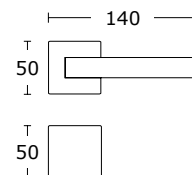

MADE
IN
GREECE



Chrom Satyna - S24
15-006



Biały Matowy - S06
25-468



Nikiel Satyna - S05
15-007



BDR 195,00 239,85



15-160 **WK 59,00** 72,57



15-161 **WB 59,00** 72,57



15-029 **WC 102,00** 125,46



BDR 213,00 261,99



25-517 **WK 64,90** 79,83



25-518 **WB 64,90** 79,83



25-519 **WC 112,00** 137,76



BDR 195,00 239,85



15-164 **WK 59,00** 72,57



15-165 **WB 59,00** 72,57



15-026 **WC 102,00** 125,46

MODEL
925



Nikiel Satyna - S05
15-003



BDR 194,00 238,62



15-164 **WK 59,00** 72,57



15-165 **WB 59,00** 72,57



15-026 **WC 102,00** 125,46

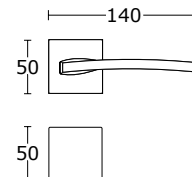

Chrom Satyna - S24
15-002



BDR 194,00 238,62



15-160 **WK 59,00** 72,57



15-161 **WB 59,00** 72,57



15-029 **WC 102,00** 125,46



Mosiądz Matowy - S26
15-395



BDR 215,00 264,45



15-412 **WK 64,90** 79,83



15-413 **WB 64,90** 79,83



15-414 **WC 112,00** 137,76



Mosiądz Antyczny - S73
15-077



BDR 215,00 264,45



15-183 **WK 64,90** 79,83



15-185 **WB 64,90** 79,83



15-041 **WC 112,00** 137,76

MODEL
785



Czarny Matowy - S19



szt. **126,50** 155,59



kpl. **253,00** 311,19

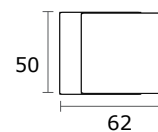

←50→



Gałki występują jako ruchome i stałe, pasują do klamek Convex na rozecie kwadratowej.
Zapytaj również o cenę gałko - klamki.

MODEL
697



Czarny Matowy - S19



szt. **104,50** 128,53



kpl. **209,00** 257,07

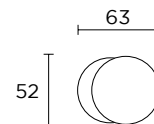

←50→



Gałki występują jako ruchome i stałe, pasują do klamek Convex na rozecie okrągłej.
Zapytaj również o cenę gałko - klamki.



KLAMKI NA ROZETACH OKRĄGLYCH

MODEL
2095

Nowości



Biały - S96
25-539

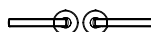

BDR 153,00 188,19



25-540 **WK 64,90** 79,83



25-542 **WB 64,90** 79,83



25-541 **WC 112,00** 137,76

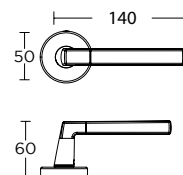

MADE
IN
GREECE



Czarny Matowy - S19
25-543



BDR 141,00 173,43



15-572 **WK 59,00** 72,57



15-574 **WB 59,00** 72,57



15-573 **WC 102,00** 125,46



Bordowy - S23
25-547



BDR 153,00 188,19



25-544 **WK 64,90** 79,83



25-546 **WB 64,90** 79,83







25-545 **WC 112,00** 137,76

MODEL
1755



Czarny Matowy - S19
25-445



	BDR 162,00	199,26
	15-572 WK 59,00	72,57
	15-574 WB 59,00	72,57
	15-573 WC 102,00	125,46

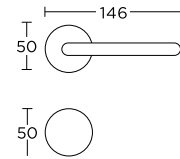



MODEL
425



Mosiądz Antyczny - S73
15-091



	BDR 209,00	257,07
	15-190 WK 64,90	79,83
	15-192 WB 64,90	79,83
	15-095 WC 112,00	137,76

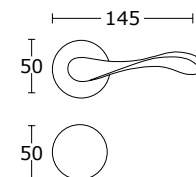

MODEL
1515

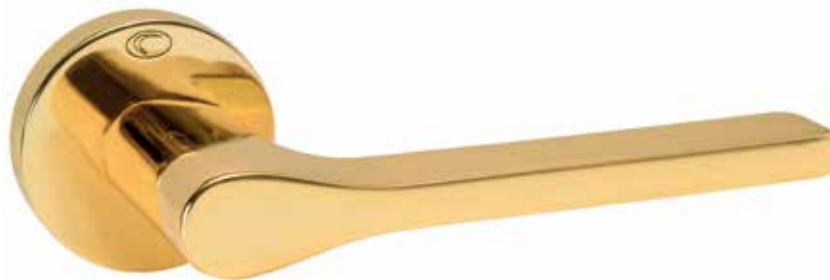

Złoty - S20
15-515



BDR 195,00 239,85



15-569 **WK 64,90** 79,83



15-571 **WB 64,90** 79,83



15-570 **WC 112,00** 137,76

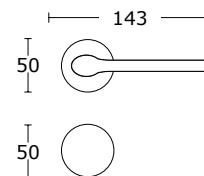

Czarny Matowy - S19
25-187



BDR 178,00 218,94



15-572 **WK 59,00** 72,57



15-574 **WB 59,00** 72,57



15-573 **WC 102,00** 125,46



Chrom Satyna - S24
15-335



BDR 178,00 218,94



15-166 **WK 59,00** 72,57



15-167 **WB 59,00** 72,57







15-055 **WC 102,00** 125,46

MODEL
1515



Nikiel Satyna - S05
15-333



	BDR 178,00	218,94
 15-168	WK 59,00	72,57
 15-169	WB 59,00	72,57
 15-052	WC 102,00	125,46

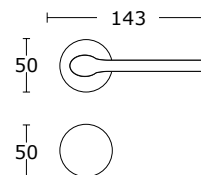





MADE
IN
GREECE



Chrom - S04
15-334



	BDR 195,00	239,85
 15-196	WK 64,90	79,83
 15-198	WB 64,90	79,83
 15-058	WC 112,00	137,76



Biały Matowy - S06
25-504





	BDR 195,00	239,85
 25-514	WK 64,90	79,83
 25-515	WB 64,90	79,83
 25-516	WC 112,00	137,76



Mosiądz Satyna - S02
15-514



	BDR 195,00	239,85
 15-415	WK 64,90	79,83
 15-406	WB 64,90	79,83
 15-416	WC 112,00	137,76

MODEL
1505



Nikiel Satyna - S05
15-336



BDR 171,00 210,33



15-168 **WK 59,00** 72,57



15-169 **WB 59,00** 72,57



15-052 **WC 102,00** 125,46

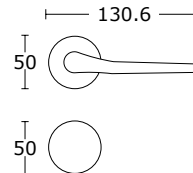

MADE
IN
GREECE



Chrom Satyna - S24
15-338



BDR 171,00 210,33



15-166 **WK 59,00** 72,57



15-167 **WB 59,00** 72,57



15-055 **WC 102,00** 125,46



Chrom - S04
15-337



BDR 187,00 230,01



15-196 **WK 64,90** 79,83



15-198 **WB 64,90** 79,83



15-058 **WC 112,00** 137,76

MODEL
1505



Złoty - S20
15-512



BDR 187,00 230,01



15-569 **WK 64,90** 79,83



15-571 **WB 64,90** 79,83



15-570 **WC 112,00** 137,76

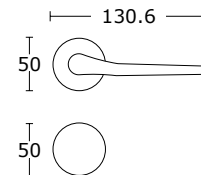

Czarny Matowy - S19
25-188



BDR 171,00 210,33



15-572 **WK 59,00** 72,57



15-574 **WB 59,00** 72,57



15-573 **WC 102,00** 125,46



Mosiądz Satyna - S02
15-418



BDR 187,00 230,01



15-415 **WK 64,90** 79,83



15-406 **WB 64,90** 79,83



15-416 **WC 112,00** 137,76

MODEL
1485



Mosiądz Satyna - S02
15-417



BDR 195,00 239,85



15-415 **WK 64,90** 79,83



15-406 **WB 64,90** 79,83



15-416 **WC 112,00** 137,76

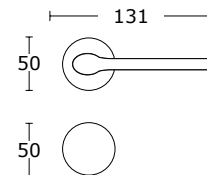

MADE
IN
GREECE



Chrom - S04
15-344



BDR 195,00 239,85



15-196 **WK 64,90** 79,83



15-198 **WB 64,90** 79,83



15-058 **WC 112,00** 137,76



Chrom Satyna - S24
15-346



BDR 178,00 218,94



15-166 **WK 59,00** 72,57



15-167 **WB 59,00** 72,57



15-055 **WC 102,00** 125,46



Nikiel Satyna - S05
15-343



BDR 178,00 218,94



15-168 **WK 59,00** 72,57



15-169 **WB 59,00** 72,57



15-052 **WC 102,00** 125,46

MODEL
1485



Czarny Matowy - S19
25-483



BDR 178,00 218,94



15-572 **WK 59,00** 72,57



15-574 **WB 59,00** 72,57



15-573 **WC 102,00** 125,46

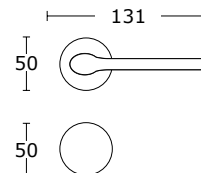

Biały Matowy - S06
25-507



BDR 195,00 239,85



25-514 **WK 64,90** 79,83



25-515 **WB 64,90** 79,83



25-516 **WC 112,00** 137,76



Mosiądz Matowy - S26
25-508



BDR 195,00 239,85



25-143 **WK 64,90** 79,83



25-144 **WB 64,90** 79,83



25-145 **WC 112,00** 137,76



Złoty - S20
15-511



BDR 195,00 239,85



15-569 **WK 64,90** 79,83



15-571 **WB 64,90** 79,83



15-570 **WC 112,00** 137,76

PROJEKTANCI CONVEX

Filozofię Convex najlepiej można opisać jako model czterofilarowy. Kreatywność, Innowacja, Technologia i Pasja. Wszystkie produkty ucieleśniają te podstawowe wartości, dzięki czemu zapewniona jest ich jakość i trwałość. Convex to jednostka produkcyjna oparta na nowoczesnej dynamice technologicznej i artystycznej, która nieustannie stara się doskonalić i dalej ewoluować. Dzięki takiemu starannemu podejściu firma Convex wytwarza pionierskie produkty o wysokich walorach estetycznych, jest rozpoznawana na całym świecie i wyróżniana za swoją jakość. Co więcej, Convex zdobył nagrody za wzornictwo dzięki utalentowanemu zespołowi projektantów firmy.

Yianis Georgaras



Yannis Georgaras urodził się w Atenach w 1973 roku, studiował wzornictwo przemysłowe w AKTO School of Applied Arts, i kontynuował na Middlesex University w Londynie. Projektuje oryginalne obiekty dla Greckich firm i organizacji. Od 2003 do 2009 roku brał udział w międzynarodowych wystawach IMM Cologne oraz DESTE Foundation w 2005 roku. W 2008 roku jego krzesło „TETRA”, wyprodukowane przez Grecką firmę VARANGIS, otrzymało nagrodę „The Red Dot Design Award”. Kolejny raz nagrodę „The Red Dot Design Award” otrzymał w 2013 roku za projekt klamki model 2055 wyprodukowanej przez firmę CONVEX S.A.

Christina Perdikaki



Christina Perdikaki urodziła się w 1980 roku, studiowała architekturę na Universitatea de Arhitectura si Urbanism „Ion Mincu” w Bukareszcie, a także wzornictwo przemysłowe na Scuola Politecnica di design SPD w Mediolanie. Łączenie przez nią jej twórczej umiejętności z nowoczesną technologią, pozwala stworzyć dowolną formę innowacyjnego projektowania koncentrującą się na meblach i sprzętach gospodarstwa domowego. Na wystawie LED (Lighting Exhibition Design), która odbyła się w Mediolanie w 2009 roku, w kategorii projekt, zdobyła nagrodę „The Ride it to Light”.

Teseo Berghella

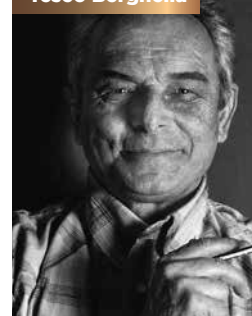

Teseo Berghella jest kreatywnym dyrektorem artystycznym, który ma doświadczenie w pracy z najbardziej znanymi międzynarodowymi agencjami reklamowymi, takimi jak: J.W.Thompson, MacCann (Mediolan i Paryż), Ogilvy, Lintas, Ted Bates, Leo Burnett. Współpracował także z Esquire i Mac Cann w Brazylii. Teseo jest także wykładowcą na kursach mistrzowskich w zakresie sztuki i wzornictwa mebli w Mediolanie, a także wykładał w NABA i Istituto Marangoni w Mediolanie. Obecnie pracuje jako projektant i dyrektor artystyczny w różnych dziedzinach, takich jak projektowanie wnętrz, kuchnia i wyposażenie domu oraz projektowanie łazienek.

PROJEKTANCI CONVEX

Valentino Marengo



Valentino Marengo

Urodził się w 1968 roku w Turynie. Studiował na Akademii Sztuk Pięknych w Turynie a następnie kontynuował studia w Mediolanie, które ukończył tytułem magistra projektowania produktów w tamtejszej Domus Academy.

Dziś mieszka w Atenach, gdzie pracuje jako projektant przemysłowy dla firm greckich i włoskich oraz scenograf.

W 2004 roku współpracował z zespołem projektowym Pininfarina Extra, m.in. przy koncepcji znicza olimpijskiego na Zimowe Igrzyska Olimpijskie Turyn 2006.

Jako scenograf pracował dla teatrów państwowych i innych scen w Grecji. Współpracuje z Muzeum Benaki i Muzeum Sztuki Cykladzkiej.

Niedawno zaprojektował logo Opery Ateńskiej. Jako artysta wizualny pokazywał swoje prace na wielu wystawach w Europie.

Yianis Gikas



Yianis Gikas urodził się w Atenach w Grecji. Jego wykształcenie łączy informatykę i wzornictwo.

Yianis wykorzystuje funkcjonalność, jako ostateczny cel jego projektów, badając potencjalne reakcje emocjonalne jakie mogą generować.

Widzi projekt jako proces zaspokojenia zarówno materialnych jak i niematerialnych potrzeb.

W 2009 roku, jego krzesło w stylu monarchistycznym, wyprodukowane przez belgijską firmę FELD, otrzymało nagrodę „The Red Dot Design Award”.

Oleg Suzdalev



Oleg Suzdalev to projektant przemysłowy, który koncentruje się na akcesoriach meblowych.

Jego projekty obejmują również oprawy, baterie zlewozmywakowe, wanny i oczywiście klamki.

W 2007 r. ukończył studia w zakresie sztuki użytkowej w Kijowie na Ukrainie.

Sotiris Lazou



Sotiris Lazou urodził się w Atenach w 1965 roku.

Studiował projektowanie wnętrz w Technological Educational Institution w Atenach i wzornictwo przemysłowe w Mediolanie na słynnej Akademii DOMUS pod nadzorem profesorów Andrea Branzi, Isao Hosoe i Ezio Manzini. Projekty Sotirisa otrzymały międzynarodowe uznanie. Jego stół „Cosmos” zdobył w 2008 roku nagrodę „Good Design Award”. Był on również nominowany w 2010 roku do „Designpreis Deutschland” (Nagrody Wzornictwa) w Niemczech.

AWARDED DESIGNERS & PREMIUM

MODEL
2405



design by **Christina Perdikaki**



Czarny Matowy - S19
25-185



BDR 310,00 381,30



15-572 **WK 59,00** 72,57



15-574 **WB 59,00** 72,57



15-573 **WC 102,00** 125,46

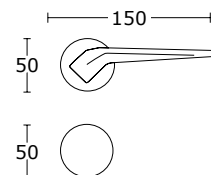

Mosiądz Satyna - S02
15-382



BDR 340,00 418,20



15-415 **WK 64,90** 79,83



15-406 **WB 64,90** 79,83



15-416 **WC 112,00** 137,76



MODEL
2415



design by **Yiannis Ghikas**

Brąz Matowy - S77
25-496



	BDR 216,00	265,68
	25-146 WK 64,90	79,83
	15-148 WB 64,90	79,83
	25-147 WC 112,00	137,76

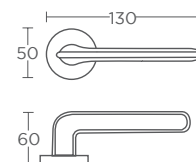

MODEL
2195



design by **Yiannis Ghikas**

Chrom / Biały - S04 / S06
15-347



	BDR 421,00	517,83
	15-196 WK 64,90	79,83
	15-198 WB 64,90	79,83
	15-058 WC 112,00	137,76

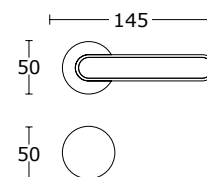

MODEL
2165





design by **Yiannis Ghikas**



MADE
IN
GREECE

Czarny Matowy - S19
15-023



	BDR 399,00 490,77
 15-162	WK 59,00 72,57
 15-163	WB 59,00 72,57
 15-038	WC 102,00 125,46

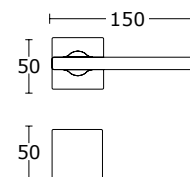

MODEL
1935

Nowości



Mosiądz Matowy / Mosiądz Błyszczący - S26 S16
25-553



BDR 464,00 570,72



25-143 **WK 64,90** 79,83



25-144 **WB 64,90** 79,83



25-145 **WC 112,00** 137,76



Mosiądz Antyczny / Złoty - S73 S20
25-552



BDR 512,00 629,76



15-190 **WK 64,90** 79,83



15-192 **WB 64,90** 79,83



15-095 **WC 112,00** 137,76

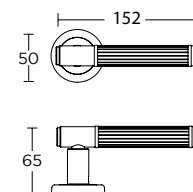

MODEL
1925

Nowości



Mosiądz Antyczny / Złoty - S73 S20
25-554



BDR 376,00 462,46

① ① 15-190 **WK 64,90** 79,83

② ② 15-192 **WB 64,90** 79,83

③ ③ 15-095 **WC 112,00** 137,76

MADE
IN
GREECE



Mosiądz Matowy / Mosiądz Błyszczący - S26 S16
25-555



BDR 376,00 462,46

① ① 25-143 **WK 64,90** 79,83

② ② 25-144 **WB 64,90** 79,83

③ ③ 25-145 **WC 112,00** 137,76

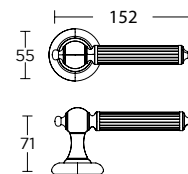

MODEL
1775





design by **Teseo Berghella**



Mosiądz Antyczny - S73
25-193



	BDR 269,00 330,87
 15-190	WK 64,90 79,83
 15-192	WB 64,90 79,83
 15-095	WC 112,00 137,76

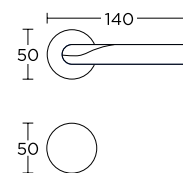

MODEL
1745



Nikiel Satyna - S05
25-140



BDR 414,00 509,22



15-168 **WK 59,00** 72,57



15-169 **WB 59,00** 72,57



15-052 **WC 102,00** 125,46

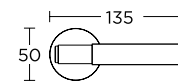

Mosiądz Matowy - S26
25-141



BDR 456,00 560,88



25-143 **WK 64,90** 79,83



25-144 **WB 64,90** 79,83



25-145 **WC 112,00** 137,76



Brąz Matowy - S77
25-142



BDR 456,00 560,88



25-146 **WK 64,90** 79,83



25-148 **WB 64,90** 79,83



25-147 **WC 112,00** 137,76



Czarny Matowy - S19
25-352



BDR 414,00 509,22



15-572 **WK 59,00** 72,57



15-574 **WB 59,00** 72,57



15-573 **WC 102,00** 125,46

MODEL
1625



design by **Oleg Suzdalev**



Mosiądz Antyczny - S73
15-854



BDR 229,00 281,67



15-190 **WK 64,90** 79,83



15-192 **WB 64,90** 79,83



15-095 **WC 112,00** 137,76

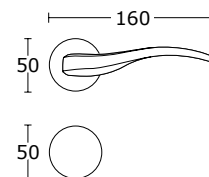

 **MADE
IN
GREECE**



Czarny Matowy - S19
15-853



BDR 209,00 257,07



15-572 **WK 59,00** 72,57



15-574 **WB 59,00** 72,57



15-573 **WC 102,00** 125,46

ROZETA QR5WK



Chrom - S04

Nikiel Satyna S05 15-164	59,00	72,57
Czarny Matowy S19 15-162	59,00	72,57
Chrom Satyna S24 15-160	59,00	72,57
Mosiądz Satyna S02 25-370	64,90	79,83
Chrom S04 15-180	64,90	79,83
Biały Matowy S06 25-517	64,90	79,83
Mosiądz Matowy S26 15-412	64,90	79,83
Mosiądz Antyczny S73 15-183	64,90	79,83
Tytan S75 15-187	64,90	79,83

ROZETA QR5WB



Nikiel Satyna - S02

Nikiel Satyna S05 15-165	59,00	72,57
Czarny Matowy S19 15-163	59,00	72,57
Chrom Satyna S24 15-161	59,00	72,57
Mosiądz Satyna S02 25-372	64,90	79,83
Chrom S04 15-182	64,90	79,83
Biały Matowy S06 25-518	64,90	79,83
Mosiądz Matowy S26 15-413	64,90	79,83
Mosiądz Antyczny S73 15-185	64,90	79,83
Tytan S75 15-189	64,90	79,83

ROZETA QR5WC



Tytan - S75

Nikiel Satyna S05 15-026	102,00	125,46
Czarny Matowy S19 15-038	102,00	125,46
Chrom Satyna S24 15-029	102,00	125,46
Mosiądz Satyna S02 25-371	112,00	137,76
Chrom S04 15-032	112,00	137,76
Biały Matowy S06 25-519	112,00	137,76
Mosiądz Matowy S26 15-414	112,00	137,76
Mosiądz Antyczny S73 15-041	112,00	137,76
Tytan S75 15-035	112,00	137,76

ROZETA R5WK



Mosiądz Satyna - S02

Nikiel Satyna S05 15-168	59,00	72,57
Czarny Matowy S19 15-572	59,00	72,57
Chrom Satyna S24 15-166	59,00	72,57
Mosiądz Satyna S02 15-415	64,90	79,83
Chrom S04 15-196	64,90	79,83
Biały Matowy S06 25-514	64,90	79,83
Złoty S20 15-569	64,90	79,83
Bordowy S23 25-544	64,90	79,83
Mosiądz Matowy S26 25-143	64,90	79,83
Mosiądz Antyczny S73 15-190	64,90	79,83
Brąz Matowy S77 25-146	64,90	79,83
Biały S96 25-540	64,90	79,83

ROZETA R5WB



Mosiądz Antyczny - S73

Nikiel Satyna S05 15-169	59,00	72,57
Czarny Matowy S19 15-574	59,00	72,57
Chrom Satyna S24 15-167	59,00	72,57
Mosiądz Satyna S02 15-406	64,90	79,83
Chrom S04 15-198	64,90	79,83
Biały Matowy S06 25-515	64,90	79,83
Złoty S20 15-571	64,90	79,83
Bordowy S23 25-546	64,90	79,83
Mosiądz Matowy S26 25-144	64,90	79,83
Mosiądz Antyczny S73 15-192	64,90	79,83
Brąz Matowy S77 25-148	64,90	79,83
Biały S96 25-542	64,90	79,83

ROZETA R5WC



Brąz Matowy - S77

Nikiel Satyna S05 15-052	102,00	125,46
Czarny Matowy S19 15-573	102,00	125,46
Chrom Satyna S24 15-055	102,00	125,46
Mosiądz Satyna S02 15-416	112,00	137,76
Chrom S04 15-058	112,00	137,76
Biały Matowy S06 25-516	112,00	137,76
Złoty S20 15-570	112,00	137,76
Bordowy S23 25-545	112,00	137,76
Mosiądz Matowy S26 25-145	112,00	137,76
Mosiądz Antyczny S73 15-095	112,00	137,76
Brąz Matowy S77 25-147	112,00	137,76
Biały S96 25-541	112,00	137,76

ROZETA QRS5WK



THIN

Czarny Matowy - S19

Nikiel Satyna S05 25-439	68,00	83,64
Czarny Matowy S19 25-436	68,00	83,64
Chrom Satyna S24 25-438	68,00	83,64
Mosiądz Satyna S02 25-437	74,00	91,02
Chrom S04 25-435	74,00	91,02
Złoty S20 25-440	74,00	91,02

ROZETA QRS5WB



THIN

Złoty - S20

Nikiel Satyna S05 25-433	68,00	83,64
Czarny Matowy S19 25-430	68,00	83,64
Chrom Satyna S24 25-432	68,00	83,64
Mosiądz Satyna S02 25-431	74,00	91,02
Chrom S04 25-429	74,00	91,02
Złoty S20 25-434	74,00	91,02

ROZETA QRS5WC



THIN

Chrom Satyna - S24

Nikiel Satyna S05 25-427	109,00	134,07
Czarny Matowy S19 25-424	109,00	134,07
Chrom Satyna S24 25-426	109,00	134,07
Mosiądz Satyna S02 25-425	119,00	146,37
Chrom S04 25-383	119,00	146,37
Złoty S20 25-428	119,00	146,37

ASSEMBLY / MONTAŻ

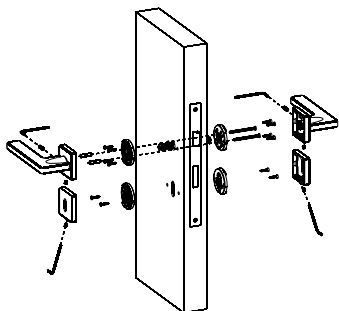

MONTAŻ KLAMKI
NA ROZECIE KWADRATOWEJ

DOOR HANDLE
WITH 2145 ROSETTE ASSEMBLY

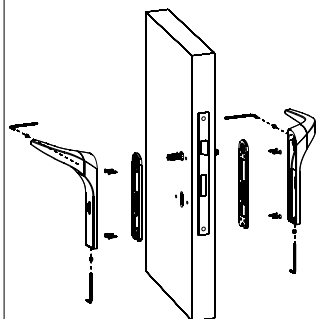

MONTAŻ KLAMKI
MODEL 2055

DOOR HANDLE
WITH 2055 ASSEMBLY PLATE

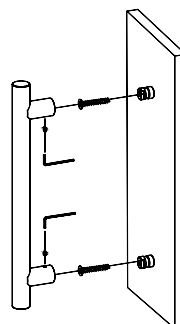

MONTAŻ POCHWYTU
JEDNOSTRONNEGO
NA DREWNOWKRĘT

SINGLE PULL HANDLE ASSEMBLY
WITHOUT HOLES

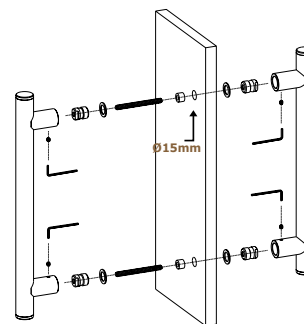

MONTAŻ POCHWYTU
DWUSTRONNEGO
DO DRZWI SZKLANYCH

PAIR PULL HANDLES ASSEMBLY
IN GLASS

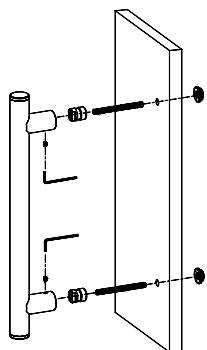

MONTAŻ POCHWYTU
JEDNOSTRONNEGO
NA PRZESTRZAŁ

PULL HANDLES ASSEMBLY
THROUGH HOLES

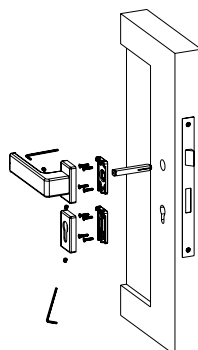

MONTAŻ KLAMKI
NA ROZECIE Q11

DOOR HANDLES
WITH NARROW ROSETTE
ASSEMBLY

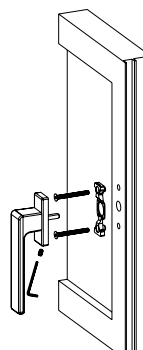

MONTAŻ KLAMKI OKIENNEJ
I BALKONOWEJ

WINDOW HANDLE ASSEMBLY

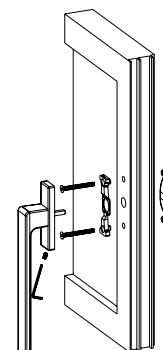

MONTAŻ KLAMKI OKIENNEJ
I BALKONOWEJ

WINDOW HANDLE ASSEMBLY

MADE
IN
GREECE

CONVEX®
HANDLES AND DESIGN & PRODUCTION



Roothkin sp. z o.o.

ul. Wieniawskiego 18, 41-506 Chorzów

zamowienia@roothkin.pl

biuro@roothkin.pl

kom. + 48 798 478 698

kom. + 48 532 726 624

tel. + 48 32 248 70 08

fax + 48 32 248 70 08

Firma Roothkin jest wyłącznym dystrybutorem marki Convex

Telefon do przedstawiciela marki Convex: + 48 532 726 622

Twoja platforma do zamawiania:

www.b2b.roothkin.pl

www.roothkin.pl

Obserwuj nas na 